

Reconfigurable Path Restoration Schemes for MPLS Networks

MARCELINO MINERO-MUÑOZ¹
VICENTE ALARCON-AQUINO¹

Department of Computing, Electronics, and Mechatronics
Communications and Signal Processing Research Group
UDLAP - Universidad de las Americas Puebla
CP. 72820 - Sta. Catarina Martir, Cholula Puebla MEXICO
¹(marcelino.minero,vicente.alarcon@udlap.mx)

Abstract. Multi-Protocol Label Switching (MPLS) is an alternative to integrate the traditional Internet Protocol (IP) routing and switching technologies because it provides end-to-end Quality of Service (QoS), guarantees Traffic Engineering, and support Virtual Private Networks (VPNs). However, MPLS must use path restoration schemes to guarantee the delivery of packets through a network. In this paper we present three reconfigurable architectures for the implementation of path restoration schemes, namely, Haskin, Makam, and Simple Dynamic. These schemes are implemented using an entity-based model that provides the advantage of reusability of entities, thus reducing the overall resource utilisation. The results show that Haskin and Makam schemes present similar resource utilisation. On the other hand, the simple dynamic scheme uses a similar entity-based model that provides a slight decrease in percentage utilisation when compared to those obtained for the two aforementioned schemes.

Keywords: MPLS, Reconfigurable Systems, Makam, Haskin, Simple Dynamic, Path Restoration.

(Received November 09, 2008 / Accepted April 26, 2009)

1 Introduction

The Internet is based on a connectionless, unreliable service, which implies no delivery guarantee. The Internet Engineering Task Force (IETF) has proposed several service models and mechanisms to provide end-to-end Quality of Service (QoS). Some of these services are integrated services like Resource Reservation Protocol (RSVP) and Multi-Protocol Label Switching (MPLS) among others. The integrated services are characterized by a resource reservation before the data transmission begins which implies route definition. In these services the datagram can be assigned to different classes. MPLS, on the other hand, offers new QoS capabilities for IP networks. MPLS technology was developed after Asynchronous Transfer Mode (ATM) and offers several services (QoS, IP Traffic Engineering support, and creation of Virtual Private Networks or VPNs), also inte-

grates layer 2 and layer 3 of the OSI model without discontinuities, and therefore combines the routing control functions of the layer 3 and commutation speed of layer 2 through a network. The MPLS technology may be applied to any layer 3 network protocol, although almost all of the interest is in using MPLS with IP Traffic [4]. This technology uses a signalling protocol to exchange messages between hosts in a network [8],[19].

The operation of MPLS is based on the classification and identification of an IP datagram with a label of local significance at the ingress node and the forwarding of this labelled datagram to intermediate nodes. The intermediate nodes use these labels to forward the datagram through the network without using the IP addresses [10]. To summarize the main objectives of the MPLS technology are an efficient management of traffic, to reduce the delay introduced by the datagram analysis, and to allow a better scalability and simplicity [9]. In case

of a link failure, MPLS must use path restoration techniques, which have the function to reroute traffic around a failure in a label switched path (LSP) [1],[11],[13]. Usually MPLS is implemented using software solutions, but recently it has been implemented in reconfigurable systems, which provide reduced time of processing and facility to upgrade [15],[16],[20], among others advantages. MPLS hardware implementations without considering path restoration schemes have been reported in [7],[14],[15],[16],[20]. This type of implementation requires the use of signalling protocols like Label Distribution Protocol (LDP), Constraint-Based LDP (CR-LDP) or RSVP in reconfigurable systems. These protocols implement only the time-critical operations (label request, label mapping, etc.) [12],[21],[22].

In the work reported in this paper we implement a general algorithm to model the session establishment between several routers inside an MPLS network. In contrast with previous implementations of the MPLS technology, this paper includes the implementation of Makam, Haskin, and simple dynamic path restoration schemes [10],[11],[13]. Note that we focus on modelling of path restoration schemes in reconfigurable systems rather than network dropped packets; therefore, we assume that only one packet is in transit on the network at any time. A compilation of some path restoration schemes for MPLS networks can be found in [1], [2], [3], [5], [6], [10] in which simulations of several schemes is presented. These works are used as a reference for the implementation of path restoration schemes in reconfigurable systems for MPLS networks using Very high-speed integrated circuits Hardware Description Language (VHDL). The rest of the paper is organised as follows. Section 2 presents an overview of the MPLS technology. In Section 3 we present a description of three path restoration schemes. The proposed models for the implementation of three schemes are presented in Section 4 along with the proposed model for a signalling protocol. The implementation results are presented in Section 5. Conclusions and future work are presented in Section 6.

2 MPLS Components and Operation

This section gives an overview of the terms associated with the MPLS technology. The main components associated to an MPLS network are shown in Figure 1. The function of ingress Label Edge Router (LER) is to put a label in the IP packet and forward it to the next hop in the MPLS network. This label is assigned according to the forwarding equivalence class (FEC) of the packet. In this case the IP packet is encapsulated in an MPLS Protocol Data Unit (PDU), with an MPLS

shim header included in the packet. The main objectives of MPLS are accomplished using fixed-length labels. These labels included in an MPLS header (shim header) are assigned considering FECs that determine the route of a datagram. The FECs are a representation of a group of packets that share the same requirements to their transport. These FECs can be used to support QoS operations (e.g. real time applications) [9]. This FEC to label relationship determine the Label Switched Path (LSP) of a datagram, from the ingress point to the egress point of the MPLS network. In the MPLS domain of Figure 1 the router R0 (an ingress LSR), using a signalling protocol, determines that it can reach the network 172.161.0.0 through the interface S0 using the label 200. Additionally, R0 determines that using the interface S1 it can send packets to the network 140.148.0.0 using the label 400. In other words, two FECs have been established. Figure 1 also shows the LSPs associated with a specific FEC. The complete path through an MPLS network is known as LSP.

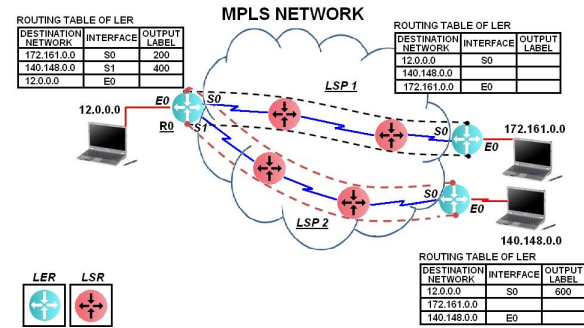

Figure 1: MPLS domain with LSRs, LERs, two LSPs and associated FECs.

The LSP or “tunnel” at both ends of the MPLS network is a concatenation of the LSP segments between each node. In this tunnel the ingress node define the type of traffic and assigns a label. According to this label, the traffic is forwarded through the LSP without further examination. At the end of the tunnel, the egress node removes the label and forwards the traffic to an external network (e.g. an IP network). This type of tunnels allows the implementation of Traffic Engineering (TE). Given the advantages of MPLS over traditional IP routing, the option of implementing this technology is in Application-Specific Integrated Circuit (ASICs) or in General Purpose Processors (GPP). The problem of using ASICs to implement MPLS is that the system does not allow future configurations. This problem does not exist in the GPP, but it has less datagram processing capacity. Another option is to implement MPLS in reconfigurable systems [7],[14],[15],[16],[20]. This type of implementation allows the re-configuration of hard-

ware when exist a change in the protocols or technologies involved. The MPLS label, among other fields, is part of a shim header with the structure shown in Figure 2.



Figure 2: Structure of an MPLS shim header.

The Time to Live field (TTL) indicates the period of time in which the datagram is valid. The Stack field (S) indicates the existence of additional labels assigned to the datagram. The Experimental field (EXP) does not have a formal definition in the MPLS technology, but it is used in Cisco label switching for Class of Service (CoS). Finally, the Label field contains a 20-bit value at the front of the packet. Note that additional information can be associated with a label—such as CoS values—that can be used to prioritize packet forwarding.

The most used terms to describe the routing tables in the MPLS technology are the Label Information Base (LIB) and Label Forwarding Information Base (LFIB). The LIB contains the labels associated to a determined address and the address itself associated with these labels. These associations are those generated in this LSR and also those received from the LSRs in the neighbourhood. The LFIB table contains only the necessary information to forward a datagram to the next hop in the LSP. This information consists on local labels (to be used between two LSRs on the same LSP and created by the LSR with this LFIB) and the output labels. This table also contains information of the interface to be used to forward the traffic to the next hop. An egress LER removes the label of the IP packet and forwards it to a traditional IP network. The Label Switch Routers (LSRs) are devices capable of forwarding packets inside an MPLS network. These routers are located inside the MPLS network and are intermediate hops between the ingress and egress LERs. Their function is to examine the labels of the received packets and replace them with another label according to the routing table of the intermediate routers.

3 Path Restoration Schemes

The implementation of MPLS in reconfigurable systems must include a solution to a path or route failure, and thus the inclusion of path restoration schemes in this implementation is necessary. These schemes are based on the kind of failure and each one has characteristics that make it preferable over others [2], [17]. There are several path restoration schemes that are used for com-

parison purposes when a new architecture is proposed. Some of these schemes are Haskin [11], Makam [13] and simple dynamic [1]. In addition to these schemes, there are others like Fast Rerouting, Reliable Fast Rerouting and Optimal Guaranteed Alternate Path (see e.g. [10]). The application of these schemes depends on the specific requirements of the network [17]. These schemes forward traffic around a failure in a primary route and their objective is to minimize the time of establishment of the alternate route and avoid the excessive lost of information. These schemes can be classified according to the following criteria:

Local Repair: Minimizes the amount of time required for failure propagation. Hence, if the restoration can be realized in local manner it can be accomplished faster.

Global Repair: Considers that the nodes and links along the primary route are protected by one restoration route. In case of failure, the restoration scheme sends a Failure Indication Signal (FIS) to the ingress LSR node (also known as LER) and when it receives this FIS the alternate route is activated from this node.

3.1 Simple dynamic Scheme

This scheme uses local repair and dynamic activation. Hence the alternate route is established when the point of failure is detected (see Figure 3). When a failure in the primary route occurs, this scheme finds an alternate route that continues from the node that detects the failure. This scheme can consider link failures as well.

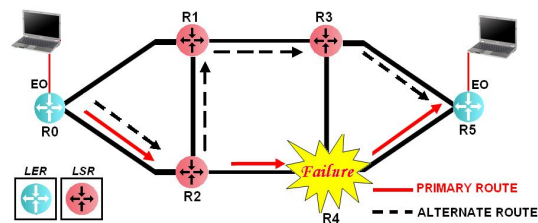

Figure 3: Simple dynamic scheme.

3.2 Haskin Scheme

This restoration scheme uses alternate routes previously established with local repair (see Figure 4). One of the requirements of this method is that the network topology allows the establishment of the alternate route between the ingress and egress LSRs (also known as LER) of the LSP tunnel, in such way that the alternate LSP does not share any resource with the route to be protected [11]. The main idea of this scheme is to return the traffic from the point of failure on the protected LSP to the ingress LSR so that the traffic could be redirected

through an alternate route between the ingress LSR and the egress LSR of the protected tunnel.

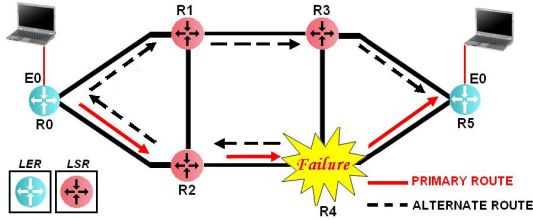

Figure 4: Haskin scheme.

The alternate route is established as follows [11]. The initial segment of the alternate LSP is between the last hop LSR before the point of failure and the ingress LSR (also known as LER) in opposite direction of the protected LSP. The final segment of the alternate route is defined between the ingress LSR and the egress LSR.

3.3 Makam Scheme

This scheme uses global repair and allows dynamic and pre-negotiated activation of the alternate route (see Figure 5). However, the dynamically established alternate routes add more time to the restoration operation compared with the pre-negotiated activation.

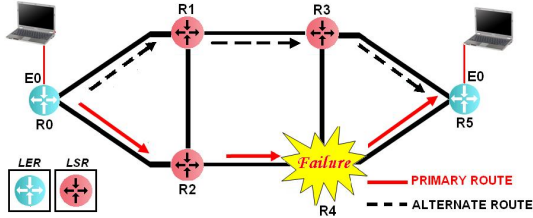

Figure 5: Makam scheme.

The establishment of the alternate route for this scheme is as follows [10], [13]. Firstly, when a failure is detected, the node detecting the failure sends a failure indication signal (FIS) to the ingress node. Secondly, all the packets in transit between the failure detection and the moment in which the FIS arrive to the ingress node are lost. Finally, when the ingress node receives the FIS redirects the traffic through an alternate route to the egress node. The main difference of this scheme and the Haskin scheme is that it does not redirect the traffic from the point of failure; instead it redirects traffic from the ingress node.

4 Modelling of Path Restoration Schemes

The implemented models for path restoration in MPLS networks are presented considering a network with a determined number of routers or nodes. The proposed

models are implemented in a FPGA XC3S1000 from Xilinx [23] and the throughput is calculated for every model proposed.

4.1 Simple dynamic Model

The network topology used for this scheme is shown in Figure 6. The reason for this topology is discussed in the following sections. Each of these 5 routers is considered to have 6 interfaces. Each interface has 2 unidirectional links. From now on, each of these routers is referred to as MPLS nodes without considering whether it is an LER or an LSR router. The model of each of these nodes is accomplished using the block diagram shown in Figure 7. The signals involved in this block diagram are described as follows:

Read Only Memory (ROM): Provides the signals IRTR_DATA, ILB_ADD and NETS. An MPLS classifier uses these signals. ENABLE is a global signal to enable the system.

NETS (L = 64 bits): This signal contains those IP addresses of the nets interconnected to the MPLS networks.

ILB_ADD (L = 32 Bits): Provides the Loopback Address of each MPLS node.

IRTR_DATA (L = 24 Bits): This signal has four functions. Define the interface type of the MPLS nodes (connected to another interface of an MPLS node or connected to the ingress or egress points of the network). Another function of this signal is to define the state of the interfaces of the MPLS node (enable or disable). It assigns the external network prefix of networks connected to LER nodes. The final function is to assign a unique number to each node in the MPLS network.

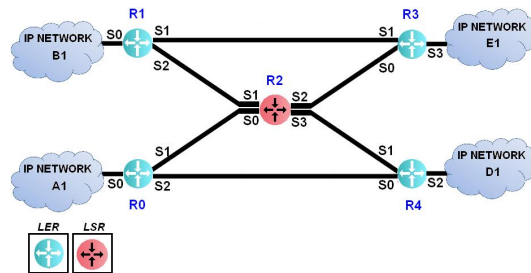

Figure 6: Network topology for simple dynamic scheme.

PROG_BITS (L = 7 Bits): This signal is provided to test the path restoration scheme. It has two fields. The first one indicates the node in which a failure occurs. The second field indicates the interface of the MPLS node in which a failure is located. An optional block named Failure Detector (FD) can provide the PROG_BITS signal.

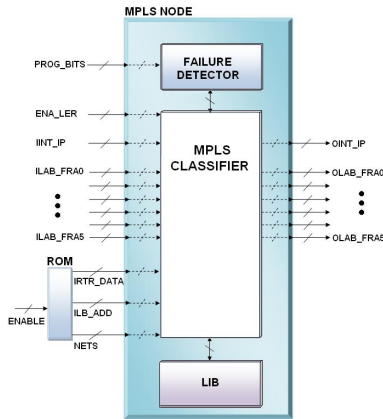

Figure 7: Block diagram for an MPLS node.

ENA_LER (L=1 Bit): This signal indicates that the node is a LER node when it has a value of 1. It also indicates that it is receiving data from an external network.

IINT_IP (L=144 bits): It indicates a datagram from IP networks outside the MPLS domain to be processed by the MPLS classifier. The format of this signal is shown in Figure 8.

IP ADDRESS		PORT		IP DATA		LSP	FIS
SOURCE	DESTINATION	SOURCE	DESTINATION	IP DATA	LSP	FIS	
32	32	16	16	16	24	8	
BITS	BITS	BITS	BITS	BITS	BITS	BITS	

Figure 8: Format of signals IINT_IP and OINT_IP.

OINT_IP (L=144 bits): Datagram to be sent to external IP networks. The signals IINT_IP and OINT_IP are present in each node of the MPLS network, but just the LER nodes use these signals.

I/OLAB_FRA (L=176 bits): This signal is located in every interface of each LSR node and their function is to interconnect all the nodes of the MPLS network. These signals consist of an IP datagram of 144 bits (I/OINT_IP) plus an MPLS shim header of 32 bits.

Failure Detector (FD): This FD checks the signal PROG_BITS to determine if the node presents a link failure. In case of failure, sends a signal to the classifier to establish an alternate route based on the information provided by the LIB.

A. LIBs

Each node of the MPLS network has a LIB, which was generated by a signalling protocol (e.g. LDP). The general structure of these LIBs is shown in Figure 9. This LIB scheme may be modified to include more networks. These LIBs provide the following data to each MPLS node:

Number of Hops (NoH): Indicates the number of hops a packet must traverse to reach a destination (e.g. an

IP network). It is assumed that this number is obtained using a protocol like OSPF in the network initialization stage.

Local Label (LL): The router associates this label with a particular destination (FEC). This FEC is sent to more MPLS nodes.

Remote Label (RL): This label (associated to a destination or FEC) is received during the execution of the signalling protocol.

Figure 9: General structure of LIBs.

The model for the simple dynamic scheme is explained with the following example (see Figure 9). Consider that through interface S3 arrives the datagram with label 21A and a search determine that the route with the least number of hops implies to send the datagram through interface S1 with a label 11A. Using this label the datagram arrives to the destination in one hop more. In case of failure the datagram could be sent using interface S2 with label 41A and it arrives to their destination using more hops.

B. MPLS Classifier

The functions of the classifier are twofold. To determine the interface in which arrives a datagram, and to inform the interface number in which arrives a datagram to the LIB. Furthermore, it sends to the LIB a relationship of interfaces to read and an index indicating the LIB position to read. This classifier uses labels sent by the LIB, the number of hops and the signal sent by a FD to forward packets.

C. Determination of the Next Hop

When a packet arrives to an MPLS node, it determines the number of interface INT_ORIG that receives the packet (see Figure 10). This number is sent to the LIB and this returns all the local labels associated to this interface. Then the classifier determines the NoH, RL and the network position (A1, B1, D1, or E1) associated to the received label. Afterwards, the classifier sends the signal LIB_IND to the LIB indicating this position and the possible interfaces INT_2_RD from which can obtain a possible remote label.

D. Operation of an MPLS Network (simple dynamic)

The LIB performs a second search of all the possible re-

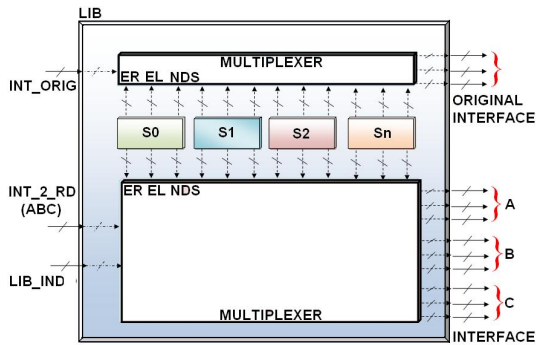

Figure 10: Block diagram of LIB and associated signals..

remote labels associated to this position and sends them to the classifier. The classifier discriminates those remote labels that have a bigger NoH than the associated with the local label received and choose the remote label with the smaller NoH. Once this label is established, the classifier changes the old label for this new remote label and send the datagram through the interface associated to the new remote label. This section presents the operation of the MPLS network from the moment that a packet arrives to one interface to the moment in which this packet leaves the MPLS network. Figure 11 and 12 shows the datagram processing in an MPLS network using the simple dynamic model. This process is described as follows:

1. An IP datagram with network prefix B1 arrives to the MPLS network through interface 0 of router R1. The destination of this datagram is the network with prefix D1.
2. Router R1 performs an analysis to determine the destination network.
3. The router R1 performs a search on LIB1 to find the appropriate remote label to process this datagram. According to this, a shim header with the label 23A included is added to the datagram. This label has associated the interface S2. In case of failure the shim header uses the label 43A.
4. The packet with label 23A arrives to R2 to be processed, and after a search in LIB2, R2 determines that the label 23A must be replaced with the label 33A and send the packet through the interface S3.
5. The packet with label 33A arrives to R3 to be processed, and after a search in LIB3, R3 determines that this packet does not require another label, since R3 is the last hop inside the MPLS network.
6. R3 pops the label from the packet and send it to the network D1 to be processed.

Figure 12 also shows the alternate route in case of a link failure in the first link.

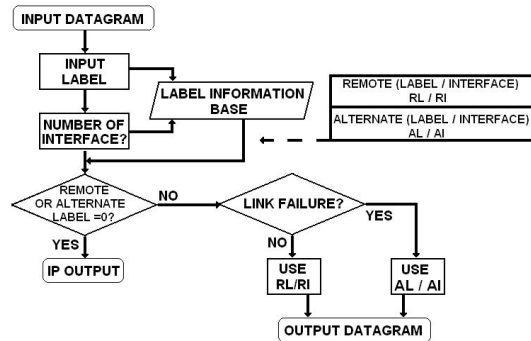

Figure 11: Flowchart for simple dynamic model.

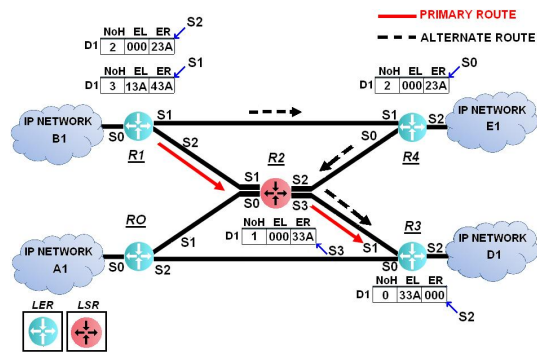

Figure 12: Label swapping in an MPLS network using the simple dynamic model.

4.2 Haskin and Makam Models

The network topology used in the schemes of Haskin and Makam and the signals associated are presented in the following sections. It is important to mention that these schemes use pre-established routes and provide end-to-end protection; hence in case of some difference this will be mentioned.

A. Topology used in Haskin and Makam Schemes

A network with 8 MPLS nodes is defined as shown in Figure 13. Each node has 6 interfaces with two uni-directional links. This topology is used because these schemes require that the alternate route do not share elements with the primary route.

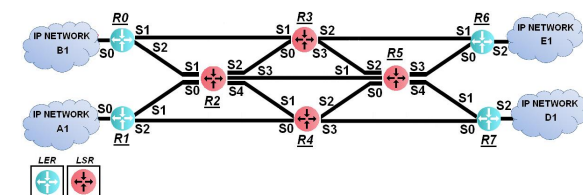

Figure 13: Network topology for Haskin and Makam schemes.

The models for the MPLS nodes are the same than those models proposed for the simple dynamic scheme.

As a result, the signals IRTR_DATA, ILB_ADD, IINT_IP, OINT_IP, ILAB_FRA, and OLAB_FRA have the same purpose and format discussed previously. Furthermore, the internal structure of the MPLS nodes is essentially the same as the proposed for the simple dynamic scheme. It is clear that there is no need to compare alternate routes since these schemes use routes previously established. Instead, these nodes just swap the incoming label with an outgoing label. These outgoing labels are obtained from the LIBs associated to each node.

B. LIBs

Consider that these LIBs could be generated using a signalling protocol (e.g. LDP) or using Read Only Memories. Recall that the Haskin scheme uses pre-established routes; as a result each node must search the incoming label and swap it with an outgoing label and the associated interface. In case of link failure the labels associated to the alternate route are used and the traffic is re-directed through the original interface. The operation of these LIBs is described as follows (see Figure 14). Suppose a datagram with label W1 arrives to an MPLS node through interface S0. The search in the associated LIB shows that this label is in position POS2. Accordingly, the outgoing label is searched in all the interfaces of this node. The result of this search shows the outgoing label X1 and the associated interface S5. Hence, the datagram is sent through S5 with a label X1. When a failure occurs in the link associated to S5, the datagram is sent through S0 using the label associated to the alternate route. S0 is used to send the datagram back to the ingress node. If the MPLS node receives a datagram with a label associated to an alternate route and a signal of failure is present, then the search of the outgoing label is made in the labels associated to the alternate route.

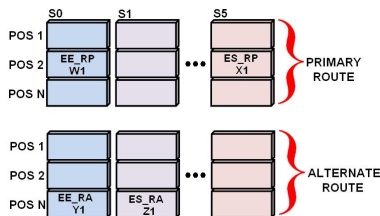

Figure 14: General structure of LIB in Haskin scheme.

C. Operation of an MPLS Network (Haskin, Makam)

The flowchart of Figure 15 shows the datagram processing in an MPLS network using Haskin model. The process of path restoration for these schemes can be explained as follows (see also Figure 16). As an example, consider a datagram that ingress to the MPLS network through node R1 and their destination is the network

connected to R6. Moreover, a link failure exists between interface S2 of R1 and interface S1 of R2. The path restoration is accomplished in a similar way for both schemes. The path restoration procedure is as follows:

1. An IP datagram, with network prefix B1 arrives to the MPLS network through interface 0 of node R0. The destination of this datagram is the network with prefix D1.
2. Node R1 analyses the datagram to determine the network to which the datagram must be sent.
3. Node R1 searches in LIB1 to find the remote label to process the datagram. The label associated to interface S2 is 523A. The remote label associated to the alternate route is 543B, and it could be used in case of failure in the link associated to S2.
4. The packet with label 523A arrives to node R2 to be processed. The search algorithm in LIB2 determines the outgoing label to be 533A and send it through interface S4.
5. The packet labelled with 533A arrives to R3 and the search algorithm in LIB3 determines the next label to be 563A and it must be send through interface S3.
6. The packet with label 563A arrives to node R6 and the search algorithm in LIB6 finds that there is no remote label associated to this label since R6 is the last hop inside the MPLS network.
7. The node R6 pops the label from packet and sends it to network D1 to be processed.

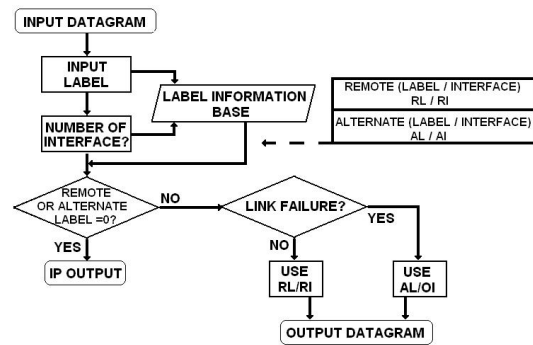

Figure 15: Flowchart for Haskin model.

Note that Figure 16 includes only those labels associated to the primary route and those associated to the alternate route.

5 Implementation Results

In this section we present the results of the implementation of path restoration schemes in a reconfigurable architecture as well as their utilisation percentages.

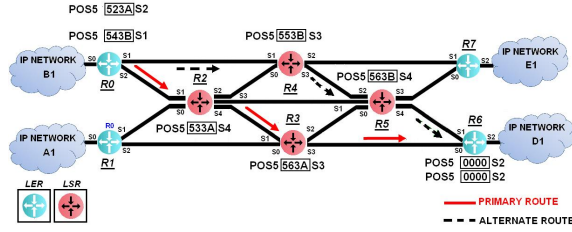

Figure 16: Label swapping in an MPLS network using the Haskin or Makam model.

5.1 Implementation of the Proposed Reconfigurable Architecture for simple dynamic scheme

The simulation of this scheme is carried out in VHDL based on the structure shown in Figure 17. The five entities named LIB_R0 to LIB_R4 show the interconnection of these entities to their respective nodes. The entity ROM represents a ROM memory that provides configuration signals to each node of the MPLS network (IRTR_DATA, ILB_ADD and INETS). The entity SD represents at the same time the MPLS classifier and the Failure Detector. The entity simple dynamic (SD) is used five times, since each one represent an MPLS node (LSR or LER).

These entities are grouped by a general entity named SD_NET that represents the MPLS network. This entity assumes that the MPLS network can be connected to 4 external IP networks. Figure 17 also shows the signals IINT_IP and OINT_IP and PROG_BITS described previously. The signal PROG_BITS defines the link failures in the MPLS network and these failures are defined in an entity named IP_FEED. Furthermore, the entity IP_FEED can send packets through the interfaces of the MPLS network to simulate the arrival of IP packets to the network. The graphical representation of this MPLS network in the reconfigurable architecture is shown in Figure 18. This representation includes each node of the MPLS network and the links associated to these nodes. The results of this implementation are shown in Figure 19. This implementation considers a link failure in the link L12 between R1 and R2. The arrows show the route to be followed by the datagram (R1L14-R4L24-R2L23-R3S2). The utilisation percentage and throughput of this implementation are shown in Table 1. The utilisation percentage is given by the software tool (from Xilinx) and the second one is obtained using parameters like maximum frequency of the reconfigurable system (50MHz), number of bits to process (label of 20 bits), and the number of clock cycles used to process a datagram (2 clock cycles) [18] equivalent to 0.04 microseconds.

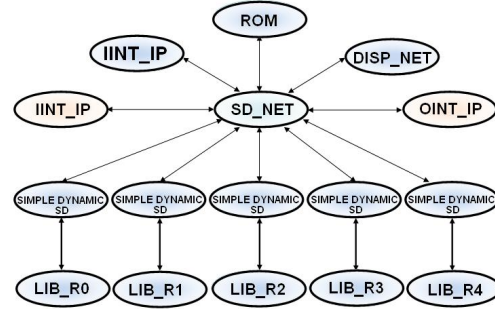
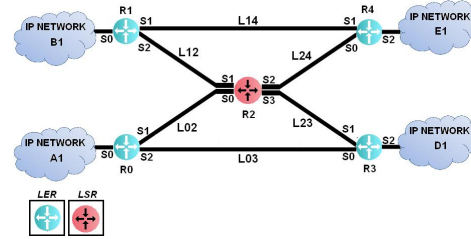
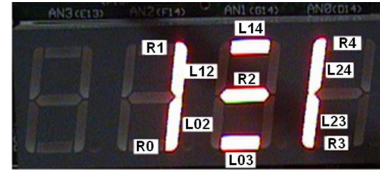

Figure 17: Interconnection of entities for simple dynamic scheme.



(a)



(b)

Figure 18: a) Network topology for the simple dynamic scheme and b) Graphical representation of datagram processing.

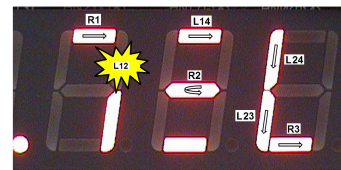

Figure 19: Graphical representation of a datagram sent from R1 to R3.

Table 1: System Utilisation using simple dynamic architecture.

Logic Utilisation	Used	Available	Utilisation	Throughput
Number of Occupied Slices	4216	7680	54%	500 Mbits/sec
Total Number of Slices Registers	2564	15360	16%	
Total Number of 4-Input LUTs	7756	15360	50%	
Number of Bonded IOBs	21	173	12%	

5.2 Implementation of the Proposed Reconfigurable Architecture for Haskin scheme

Similarly to the simple dynamic scheme, in the Haskin scheme entities are declared defining the LIBs associated to each node of the MPLS network. These LIBs

are identified as LIB_R0 to LIB_R7. Figure 20 shows the entities interconnection for the proposed topology. The entity Haskin (HK) represents at the same time the MPLS classifier and the Failure Detector. The entity HK is used eight times, since each one represent an MPLS node (LSR or LER). The function of the principal entity HK_NET is to provide interconnection between all the entities shown in Figure 20. Once the necessary simulations are carried out the proposed Haskin path restoration scheme is implemented in the reconfigurable architecture. The graphical representation of this MPLS network in the reconfigurable architecture is shown in Figure 21. The results of this implementation are shown in Figure 22. This graphical representation considers the failure in the link between R1 and R2. The arrows show the route to be followed by the packet (R1L14-R4L45-R5L56-R6S2).

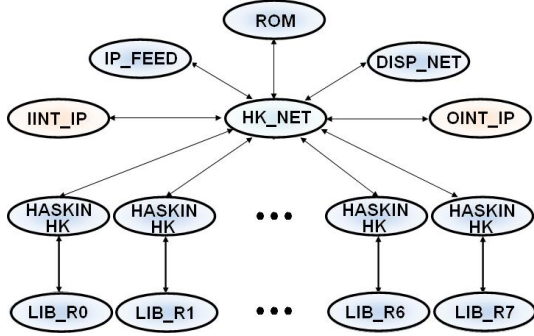
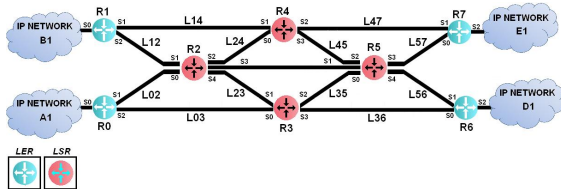
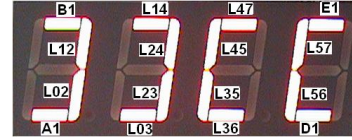

Figure 20: Interconnection of entities for Haskin scheme.

The limitation of this implementation requires that only one packet must be in transit in the MPLS network at any time. This limitation avoids the possible arrival of two packets to one node at the same time. One possible solution to this limitation could be the inclusion of FIFO memories in each node of the MPLS network. The utilisation percentage and throughput of this implementation are shown in Table 2. The results obtained from the implementation of Haskin scheme can be extended to the Makam scheme. The utilisation percentages and throughput are the same for both models. However, when compared with those associated to the simple dynamic scheme the average utilisation percentages present an increase, resulting in an overall percentage utilisation of 92%.



(a)



(b)

Figure 21: a) Network topology for Haskin scheme and b) Graphical representation of datagram processing.

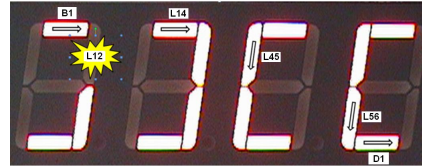

Figure 22: Graphical representation of a datagram sent from R1 to R6.

Table 2: System Utilisation using Haskin architecture.

Logic Utilisation	Used	Available	Utilisation	Throughput
Number of Occupied Slices	7134	7680	92%	
Total Number of Slices Registers	1448	15360	9%	
Total Number of 4-Input LUTs	13323	15360	86%	
Number of Bonded IOBs	20	173	11%	500Mbps/sec

6 Conclusions and Future Work

In this paper we have proposed three reconfigurable architectures for the implementation of path restoration schemes. The implemented schemes were Haskin, Makam, and simple dynamic. It was proposed an entity-based model for the implementation of the simple dynamic scheme and the implementation of this model was based on the reusability of entities. Each one of these models considers that just one packet is in transit in the network at any time. This simplification can be eliminated in a future work, using for example FIFO memories, giving as result the possibility to send and process several packets in one network, and consequently compute the quantity of input packets, processed packets, and dropped packets in one network. The implementation of the Makam's scheme gave similar results to those obtained for Haskin's scheme. In the simple dynamic model when a change in the topology is detected the LIBs' entities of each node must be accessed to determine the next hop. As a result, these entities have several inputs and outputs resulting in the shown overall utilisation. The utilisation percentages of the Haskin and simple dynamic schemes were of 92% and 54% respectively. The complexity in time was 500 Mbps. These results verify some characteristics of the MPLS technology like a small delay associated to the datagram analysis and a great scalability when it is implemented in reconfigurable architectures. The implementation of one MPLS signalling protocol was limited to the creation of the LIBs associated to each node of the net-

work. Future work and research will be focused on implementing these proposed models in real MPLS networks. Furthermore, it could be viable to implement more complex path restoration schemes like Optimal Guaranteed Alternate Path (OGAP) and QoS mechanisms [10].

References

- [1] Ahn, G. and Chun, W. Simulator for MPLS path restoration and performance evaluation. In *4th IEEE International Conference on ATM and High Speed Intelligent Internet*, pages 32–36, April 2001.
- [2] Alarcon-Aquino, V. and Martinez-Suarez, J. C. *Introduction to MPLS Networks (in Spanish)*. El Cid Editor, December 2006.
- [3] Alarcon-Aquino, V., Takahashi-Iturriaga, Y. L., Martinez-Suarez, J. C., and Guerrero-Ojeda, L. G. MPLS/IP analysis and simulation for the implementation of path restoration schemes. *WSEAS Transactions on Computers*, 3(6), December 2004.
- [4] Alicart, X. O. Design and implementation of traffic engineering research platform based on OPNET. Master's thesis, Lund University, Sweden, June 2005.
- [5] Alicherry, M. and Bathia, R. Simple pre-provisioning scheme to enable fast rerouting. *IEEE/ACM Transactions on Networking*, 15(2):400–412, April 2007.
- [6] Alouneh, S., Agarwal, A., and En-Nouaary, A. A novel path protection scheme for MPLS networks using multi-path routing. *Computer Networks*, 53(9):1530–1545, June 2009.
- [7] Altera Corporation. Application note 132 implementing multiprotocol label switching with altera PLDs, January 2001.
- [8] Andersson, L., Doolan, P., Feldman, N., Fredette, A. and Thomas, B. LDP specification, January 2001. RFC 3036.
- [9] Black, U. *MPLS and Label Switching Networks*. Prentice Hall PTR, Upper Saddle River, NJ, USA, 2002.
- [10] Gonfa, L. H. *Enhanced Fast Rerouting Mechanisms for Protected Traffic in MPLS Networks*. PhD thesis, Universitat Politècnica de Catalunya, February 2003.
- [11] Haskin, D. and Krishnan, R. A method for setting an alternative label switched path to handle fast reroute, November 2000. Internet Draft, Draft-haskin-mpls-fast-reroute-05.txt.
- [12] Li, T., Tao, Z., Wang, H., and Veeraraghavan, M. Specification of a subset of CR-LDP for hardware implementation. Technical report, Polytechnic University, New York, June 2002.
- [13] Makam, V., Sharma, V., Owens, K., and Huang, C. Protection/restoration of MPLS networks, October 1999. Internet Draft, Draft-makam-mpls-protection-00.txt.
- [14] Minero-Munoz, M. and Alarcon-Aquino, V. A hierarchical approach for modelling an MPLS network using VHDL. In *CONIELECOMP '06: Proceedings of the 16th International Conference on Electronics, Communications, and Computers*. IEEE Computer Society, February 2006.
- [15] Peterkin, R. and Ionescu, D. Embedded MPLS architecture. In *IPDPS '05: Proceedings of the 19th IEEE International Parallel and Distributed Processing Symposium (IPDPS'05) - Workshop 3*, page 170a. IEEE Computer Society, 2005.
- [16] Peterkin, R. and Ionescu, D. A hardware implementation of layer 2 MPLS. In *DELTA '06: Proceedings of the Third IEEE International Workshop on Electronic Design, Test and Applications*, pages 401–404. IEEE Computer Society, 2006.
- [17] Petersson, J. M. O. MPLS based recovery mechanisms. Master's thesis, University of Oslo, Norway, May 2005.
- [18] Rodriguez-Henriquez, F., Saqib, N. A., Diaz-Perez, A., and Koc, C. K. *Cryptographic Algorithms in Reconfigurable Hardware*. Springer, 2006.
- [19] Rosen, E. C., Viswanathan, A., and Callon, R.,. Multiprotocol label switching architecture, January 2001. RFC 3031.
- [20] Sha, L. System architecture and hardware implementations for a reconfigurable MPLS router. Master's thesis, University of Saskatchewan, Canada, August 2003.
- [21] Wang, H., Veeraraghavan, M., and Karri, R. A hardware implementation of a signaling protocol. In *Optical Networking and Communications*, pages 174–185, July 2002.
- [22] Wang, H., Karri, A., Veeraraghavan, M., and Li, T. A hardware-accelerated implementation of the RSVP-TE signaling protocol. In *IEEE International Conference on Telecommunications*, volume 3, pages 1609–1614, June 2004.
- [23] Xilinx, Inc. *Spartan-3 FPGA Family: Complete Data Sheet*, 2007. <http://www.xilinx.com/bvdocs/publications/ds099.pdf>.